

US513U61

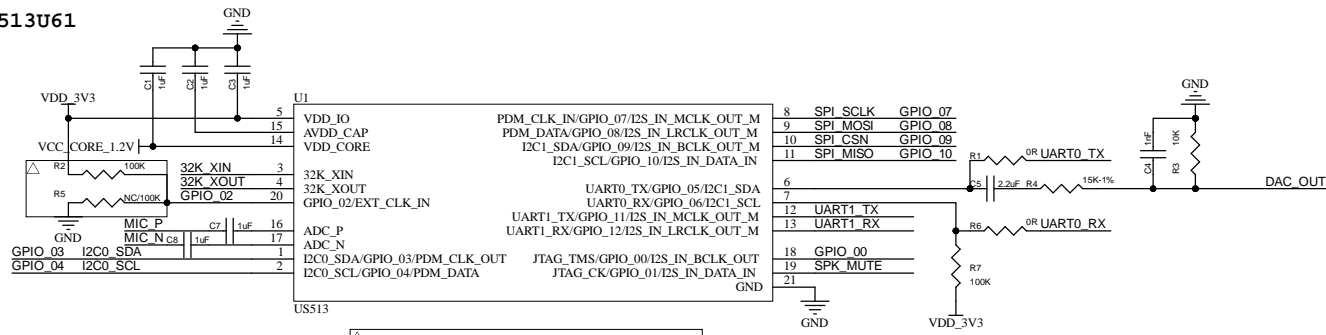

GPIO02:H addr:0x36

GPIO02:L addr:0x35

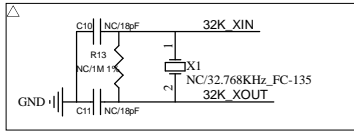

FLASH

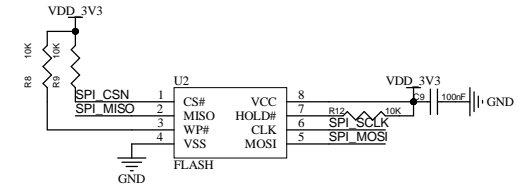

Speaker

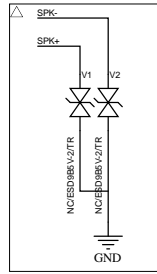
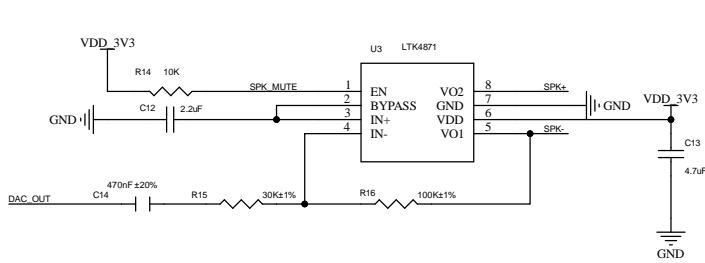

Interface

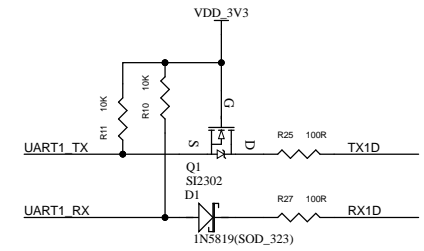
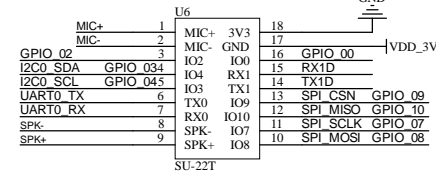

MIC

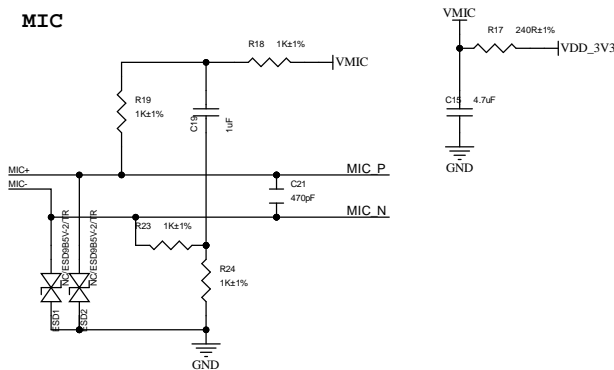

POWER

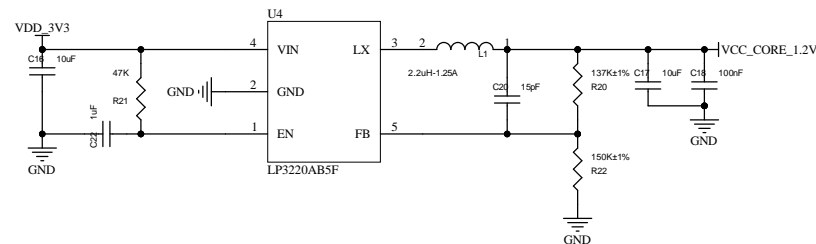

Title		
Size	Number	Revision
A3		
Date:	7/08/2022	Sheet of
File:	E:\硬件\岗上\SU-22T V1.0.SchDoc	Drawn By: